

# verona negro

NUEVO

- ✓ Colección de accesorios de baño realizada en acero inoxidable AISI 304
- ✓ Complementos de vidrio
- ✓ Tornillería de acero inoxidable
- ✓ Sistema de fijación roscada a pared mediante pletina

Material  
Acero inoxidable AISI 304

Acabado  
Negro (.N)



16880.N

41,50 €

Toallero

Dimensiones  
155 x 225 x 70 mm  
6 1/8" x 8 7/8" x 2 3/4"

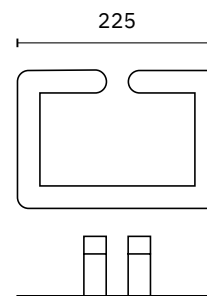

16874.N

17,10 €

Toallero perpendicular

Dimensiones  
55 x 406 x 55 mm  
2 1/8" x 1'-4" x 2 1/8"

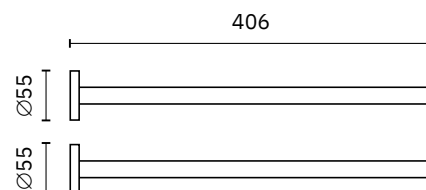

16870.60.N

37,50 €

Toallero

Dimensiones  
25 x 625 x 70 mm  
1" x 2' 5/8" x 2 3/4"

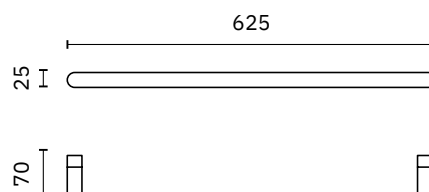

16870.40.N

33,50 €

Toallero

Dimensiones  
25 x 425 x 70 mm  
1" x 1'-4 3/4" x 2 3/4"

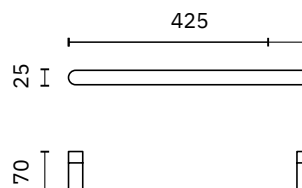

# verona negro

NUEVO

- ✓ Colección de accesorios de baño realizada en acero inoxidable AISI 304
- ✓ Complementos de vidrio
- ✓ Tornillería de acero inoxidable
- ✓ Sistema de fijación roscada a pared mediante pletina

Material  
Acero inoxidable AISI 304

Acabado  
Negro (.N)

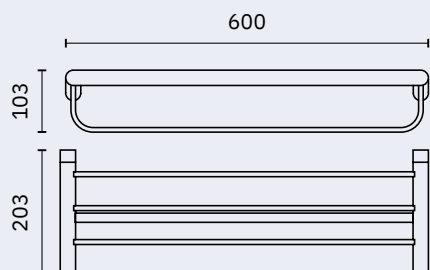

16843.N

94,00 €

Toallero con barra inferior

Dimensiones  
103 x 600 x 203 mm  
4" x 1'-11 5/8" x 8"

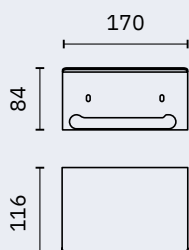
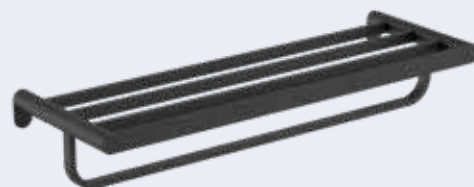

16876.N

33,50 €

Portarrollos de papel  
higiénico

Dimensiones  
84 x 170 x 116 mm  
3 1/4" x 6 5/8" x 4 1/2"

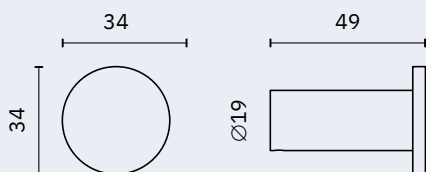
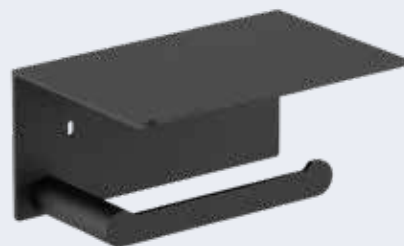

16873.N

13,20 €

Percha

Dimensiones  
34 x 34 x 49 mm  
1 3/8" x 1 3/8" x 1 7/8"

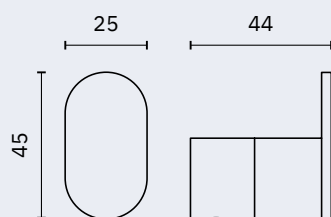

16871.N

13,15 €

Percha

Dimensiones  
45 x 25 x 44 mm  
1 3/4" x 1" x 1 3/4"

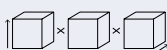

# verona negro

NUEVO

- ✓ Colección de accesorios de baño realizada en acero inoxidable AISI 304
- ✓ Complementos de vidrio
- ✓ Tornillería de acero inoxidable
- ✓ Sistema de fijación roscada a pared mediante pletina

Material  
Acero inoxidable AISI 304

Acabado  
Negro (.N)



16875.N

32,70 €

Jabonera

Dimensiones  
25 x 160 x 93 mm  
1" x 6 1/4" x 3 5/8"

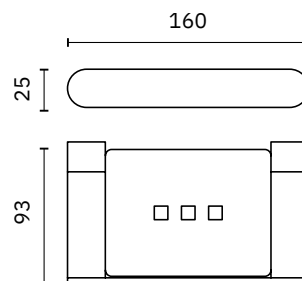

16881.N

27,55 €

Vaso para cepillo de dientes con soporte a pared

Dimensiones  
96 x 111 x 70 mm  
3 3/4" x 4 3/8" x 2 3/4"

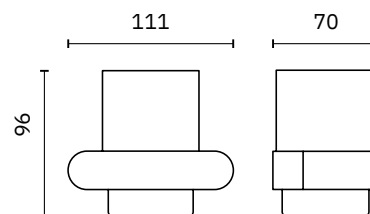

16877.N

43,60 €

Escobillero

Dimensiones  
310 x 135 x 119 mm  
1'-0 1/4" x 5 3/8" x 4 5/8"



09078.N

31,40 €

Escobillero con soporte a pared

Material  
Acero inoxidable

Dimensiones  
382 mm x Ø 105 mm  
1'-3" x Ø 4 1/4"

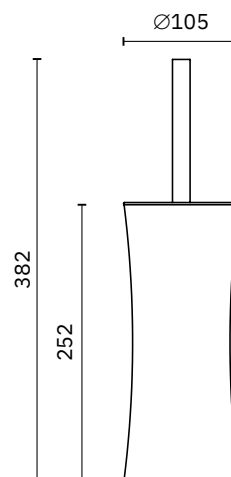

# corinto negro



- ✓ Colección de accesorios de baño realizada en acero inoxidable AISI 304
- ✓ Complementos de vidrio
- ✓ Tornillería de acero inoxidable
- ✓ Sistema de fijación roscada a pared mediante pletina

Material  
Acero inoxidable AISI 304

Acabado  
Negro (.N)

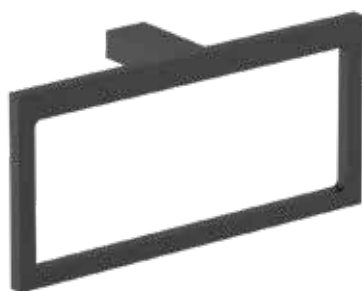

16930.N  
**43,20 €**

Toallero  
Dimensiones  
104 x 220 x 104 mm  
4 1/8" x 8 5/8" x 4 1/8"

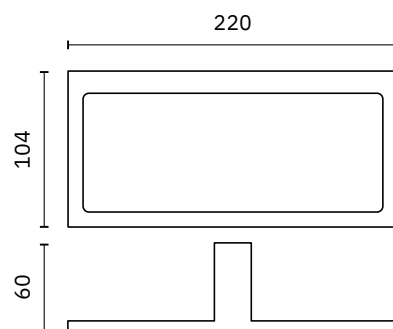

16874.N  
**17,10 €**

Toallero perpendicular  
Dimensiones  
55 x 406 x 55 mm  
2 1/8" x 1'-4" x 2 1/8"

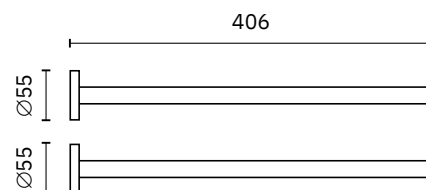

16920.60.N  
**34,20 €**

Toallero  
Dimensiones  
30 x 600 x 65 mm  
1 1/4" x 23 5/8" x 2 1/2"

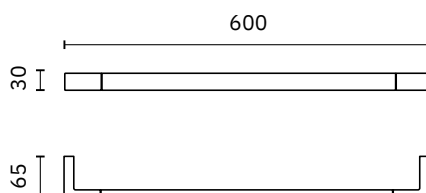

16920.40.N  
**29,95 €**

Toallero  
Dimensiones  
30 x 400 x 65 mm  
1 1/4" x 15 3/4" x 2 1/2"

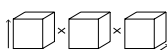
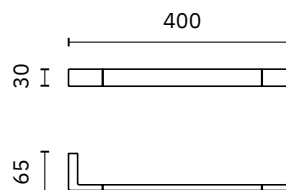

# corinto negro



- ✓ Colección de accesorios de baño realizada en acero inoxidable AISI 304
- ✓ Complementos de vidrio
- ✓ Tornillería de acero inoxidable
- ✓ Sistema de fijación roscada a pared mediante pletina

Material  
Acero inoxidable AISI 304

Acabado  
Negro (.N)

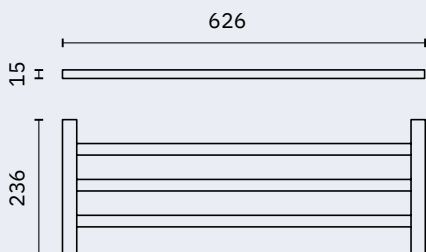

16923.N
<b>85,90 €</b>

Repisa toallero

Dimensiones  
15 x 626 x 236 mm  
0 5/8" x 24 5/8" x 9 1/4"

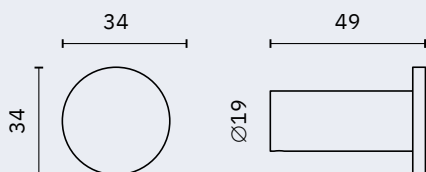

16873.N
<b>13,20 €</b>

Percha individual

Dimensiones  
34 x 34 x 49 mm  
1 3/8" x 1 3/8" x 1 7/8"

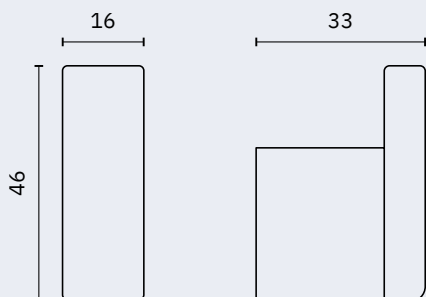

16921.N
<b>15,05 €</b>

Percha

Dimensiones  
46x 16 x 33 mm  
1 3/4" x 0 5/8" x 1 1/4"

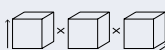

# corinto negro



- ✓ Colección de accesorios de baño realizada en acero inoxidable AISI 304
- ✓ Complementos de vidrio
- ✓ Tornillería de acero inoxidable
- ✓ Sistema de fijación roscada a pared mediante pletina

Material  
Acero inoxidable AISI 304

Acabado  
Negro (.N)



16878.N
<b>40,40 €</b>

Portarrollos de papel  
higiénico

Dimensiones  
84 x 170 x 116 mm  
3 1/4" x 6 3/4" x 4 1/2"

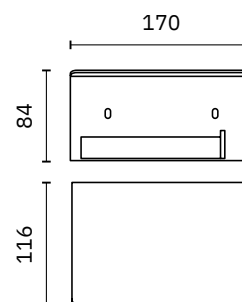

16929.N
<b>18,65 €</b>

Portarrollos

Dimensiones  
145 x 15 x 60 mm  
5 3/4" x 0 5/8" x 2 3/8"

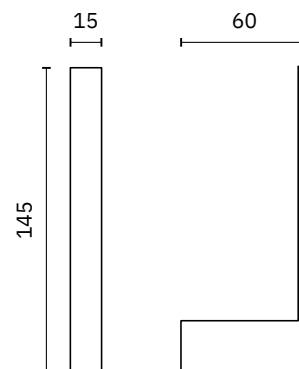

16932.N
<b>16,30 €</b>

Portarrollos reserva

Dimensiones  
15 x 161 x 60 mm  
0 5/8" x 6 3/8" x 2 3/8"

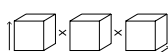
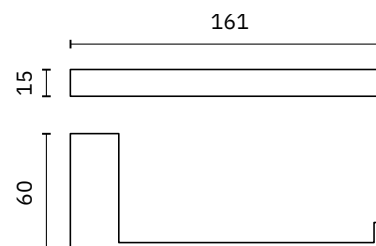

# corinto negro



- ✓ Colección de accesorios de baño realizada en acero inoxidable AISI 304
- ✓ Complementos de vidrio
- ✓ Tornillería de acero inoxidable
- ✓ Sistema de fijación roscada a pared mediante pletina

Material  
Acero inoxidable AISI 304

Acabado  
Negro (.N)

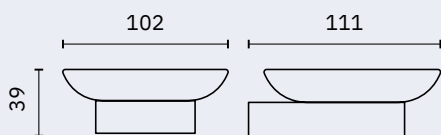

16925.N
<b>32,90 €</b>

Jabonera

Dimensiones  
39 x 102 x 111 mm  
1 1/2" x 4" x 4 3/8"

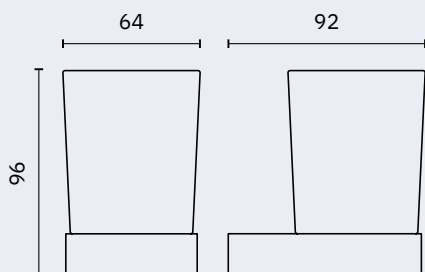
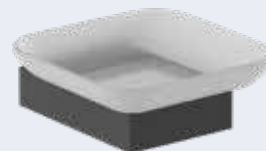

16931.N
<b>35,00 €</b>

Vaso para cepillo de dientes  
con soporte a pared

Dimensiones  
96 x 64 x 92 mm  
3 3/4" x 2 1/2" x 3 5/8"

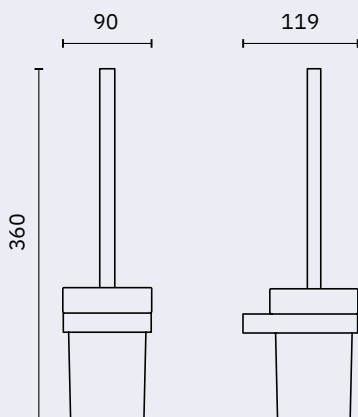
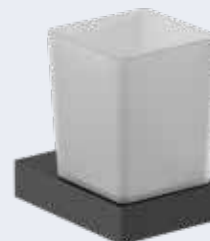

16937.N
<b>60,50 €</b>

Escobillero

Dimensiones  
360 x 90 x 119 mm  
1'-2 1/8" x 3 1/2" x 4 3/4"

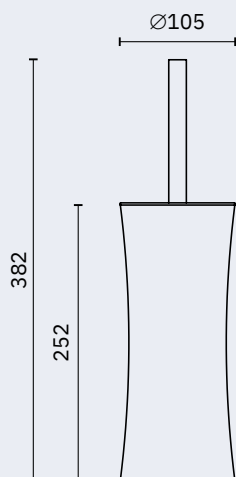

09078.N
<b>31,40 €</b>

Escobillero con soporte  
a pared

Material  
Acero inoxidable

Dimensiones  
382 mm x Ø 105 mm  
1'-3" x Ø 4 1/4"

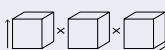

# niza negro

- ✓ Colección de accesorios de baño realizada en acero inoxidable AISI 304
- ✓ Complementos de vidrio
- ✓ Tornillería de acero inoxidable
- ✓ Sistema de fijación roscada a pared mediante pletina

Material  
Acero inoxidable AISI 304

Acabado  
Negro (.N)



16860.N

23,15 €



OTROS COLORES

Consultar

Aro toallero

Dimensiones

190 x 170 x 50 mm  
7 1/2" x 6 3/4" x 2"

Tubo Ø 10 mm

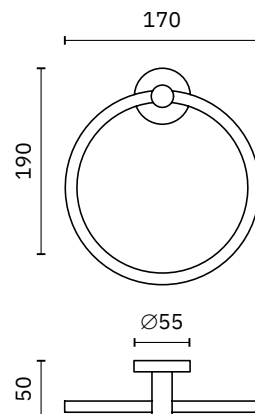

16874.N

17,10 €



OTROS COLORES

Consultar

Toallero perpendicular

Dimensiones

55 x 406 x 55 mm  
2 1/8" x 1'-4" x 2 1/8"

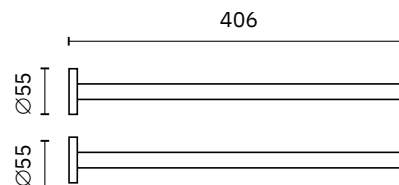

NUEVO



16850.60.N

37,40 €



OTROS COLORES

Consultar

Toallero

Dimensiones

55 x 650 x 65 mm  
2 1/8" x 2'-1 5/8" x 2 1/2"

Tubo Ø 20 mm

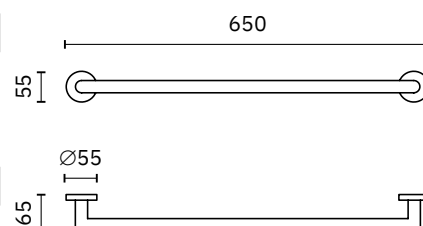

NUEVO



16850.40.N

34,20 €



OTROS COLORES

Consultar

Toallero

Dimensiones

55 x 455 x 65 mm  
2 1/8" x 1'-5 7/8" x 2 1/2"

Tubo Ø 20 mm

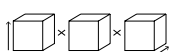
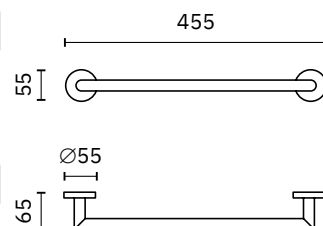



# niza negro

- ✓ Colección de accesorios de baño realizada en acero inoxidable AISI 304
- ✓ Complementos de vidrio
- ✓ Tornillería de acero inoxidable
- ✓ Sistema de fijación roscada a pared mediante pletina

Material  
Acero inoxidable AISI 304

Acabado  
Negro (.N)

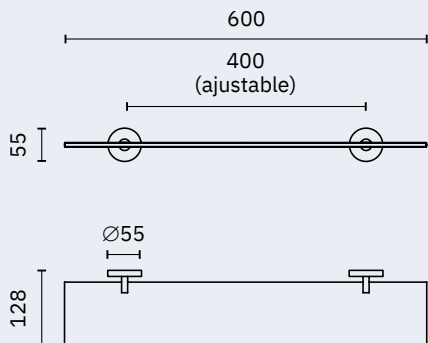

16856.N  
46,00 €



OTROS COLORES

Consultar

Repisa de vidrio

Dimensiones  
55 x 600 x 128 mm  
2 1/8" x 1'-11 5/8" x 5"

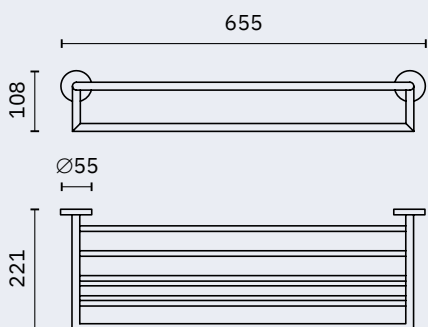

16853.N  
115,00 €



OTROS COLORES

Consultar

Repisa toallero con barra inferior

Dimensiones  
108 x 655 x 221 mm  
4 1/4" x 2'-1 3/4" x 8 3/4"

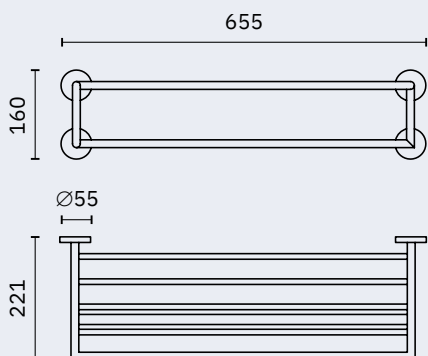
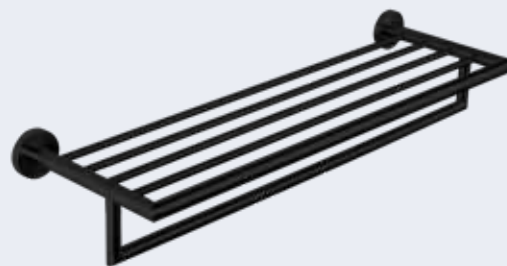

16854.N  
115,50 €



OTROS COLORES

Consultar

Repisa toallero con barra inferior y cuatro puntos de apoyo en pared

Dimensiones  
160 x 655 x 221 mm  
6 1/4" x 2'-1 3/4" x 8 3/4"

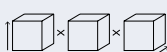
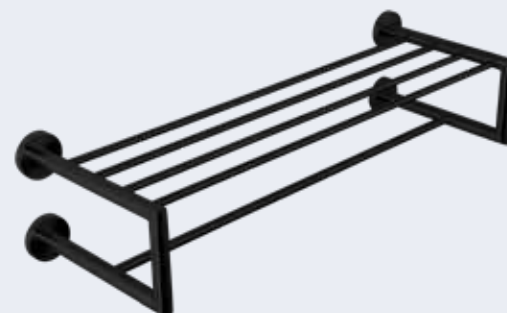

# niza negro

- ✓ Colección de accesorios de baño realizada en acero inoxidable AISI 304
- ✓ Complementos de vidrio
- ✓ Tornillería de acero inoxidable
- ✓ Sistema de fijación roscada a pared mediante pletina

Material  
Acero inoxidable AISI 304

Acabado  
Negro (.N)

NUEVO



16873.N 13,20 €



OTROS COLORES Consultar

Percha individual

Dimensiones  
34 x 34 x 49 mm  
1 3/8" x 1 3/8" x 1 7/8"

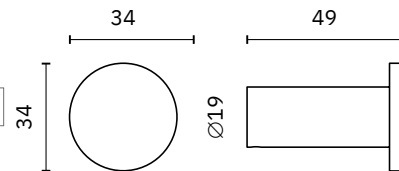

NUEVO



16849.N 14,90 €



OTROS COLORES Consultar

Percha

Dimensiones  
40x 19 x 50 mm  
1 5/8" x 0 3/4" x 2"

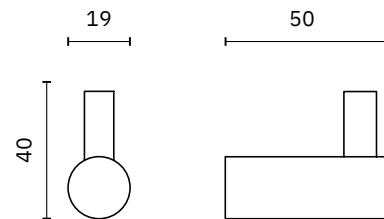

16852.N 15,65 €



OTROS COLORES Consultar

Percha doble

Dimensiones  
55 x 55 x 45 mm  
2 1/8" x 2 1/8" x 1 3/4"

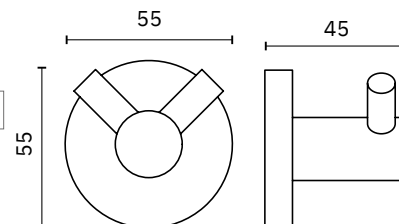

16851.N 14,65 €



OTROS COLORES Consultar

Percha

Dimensiones  
55 x 55 x 60 mm  
2 1/8" x 2 1/8" x 2 3/8"

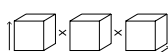
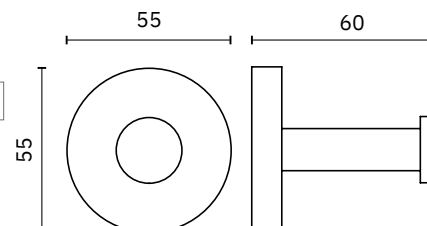

# niza negro

- ✓ Colección de accesorios de baño realizada en acero inoxidable AISI 304
- ✓ Complementos de vidrio
- ✓ Tornillería de acero inoxidable
- ✓ Sistema de fijación roscada a pared mediante pletina

Material  
Acero inoxidable AISI 304

Acabado  
Negro (.N)

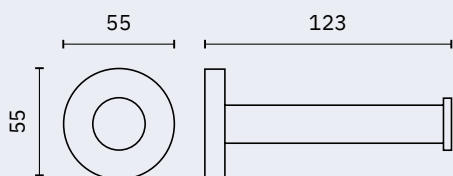

16862.N

19,75 €



OTROS COLORES

Consultar

Portarrollos de papel  
higiénico

Dimensiones  
55 x 55 x 123 mm  
2 1/8" x 2 1/8" x 4 3/8"



NUEVO

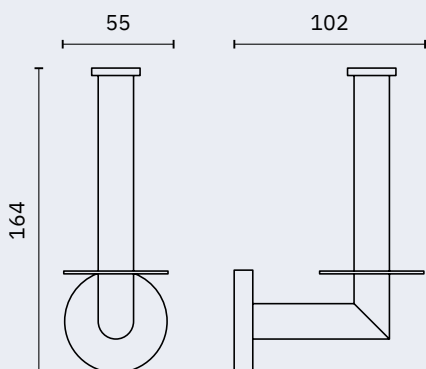

16869.N

23,95 €



OTROS COLORES

Consultar

Portarrollos reserva

Dimensiones  
164 x 55 x 102 mm  
6 1/2" x 2 1/8" x 4"



NUEVO

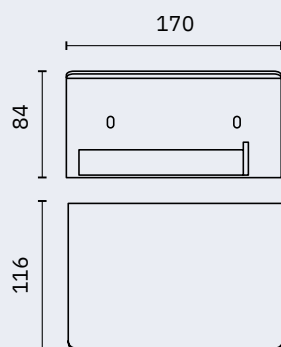

16876.N

33,50 €



OTROS COLORES

Consultar

Portarrollos de papel  
higiénico

Dimensiones  
84 x 170 x 116 mm  
3 1/4" x 6 3/4" x 4 1/2"

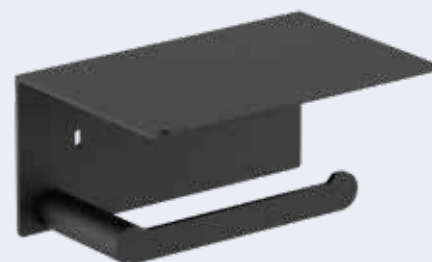

NUEVO

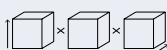

# niza negro

- ✓ Colección de accesorios de baño realizada en acero inoxidable AISI 304
- ✓ Complementos de vidrio
- ✓ Tornillería de acero inoxidable
- ✓ Sistema de fijación roscada a pared mediante pletina

Material  
Acero inoxidable AISI 304

Acabado  
Negro (.N)



16858.N  
29,50 €



OTROS COLORES

Consultar

Portarrollos de papel higiénico

Dimensiones  
133 x 138 x 65 mm  
5 1/4" x 5 3/8" x 2 5/8"

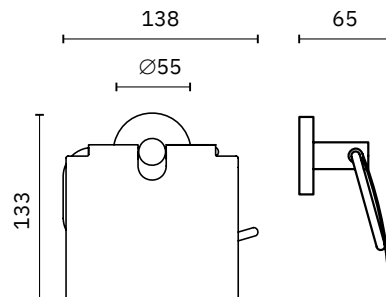

16859.N  
28,50 €



OTROS COLORES

Consultar

Portarrollos de papel higiénico

Dimensiones  
55 x 178 x 65 mm  
2 1/8" x 7" x 2 1/2"

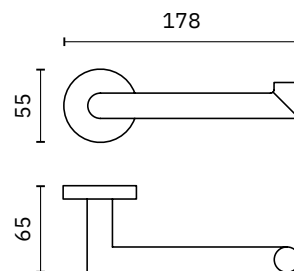

16855.N  
25,95 €



OTROS COLORES

Consultar

Jabonera

Dimensiones  
55 x 125 x 111 mm  
2 1/8" x 4 7/8" x 4 3/8"

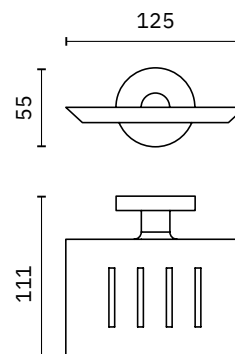

06045.FIX  
9,40 €

Adhesivo para fijación de accesorios de baño. Tubo 6 ml

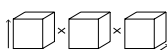

# niza negro

- ✓ Colección de accesorios de baño realizada en acero inoxidable AISI 304
- ✓ Complementos de vidrio
- ✓ Tornillería de acero inoxidable
- ✓ Sistema de fijación roscada a pared mediante pletina

Material  
Acero inoxidable AISI 304

Acabado  
Negro (.N)

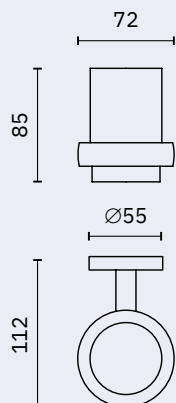

16861.N

24,20 €



OTROS COLORES

Consultar

Vaso para cepillo de dientes con soporte a pared

Dimensiones  
85 x 72 x 112 mm  
3 3/8" x 2 7/8" x 4 3/8"

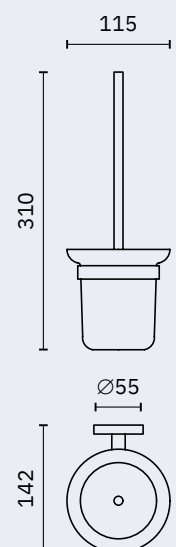

16857.N

40,20 €



OTROS COLORES

Consultar

Escobillero

Dimensiones  
310 x 115 x 142 mm  
1'-0 1/4" x 4 1/2" x 5 5/8"

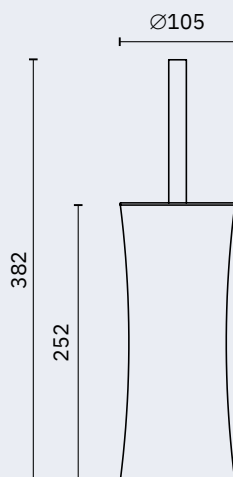

09078.N

31,40 €



OTROS COLORES

Consultar

Escobillero con soporte a pared

Material  
Acero inoxidable

Dimensiones  
382 mm x Ø 105 mm  
1'-3" x Ø 4 1/4"



NUEVO

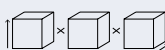

# capri negro

NUEVO

- ✓ Colección de accesorios de baño realizada en aluminio
- ✓ Complementos de vidrio
- ✓ Tornillería de acero inoxidable
- ✓ Sistema de fijación roscada a pared mediante pletina

Material  
Aluminio

Acabado  
Negro (.N)



16874.N

17,10 €

Toallero perpendicular

Dimensiones  
55 x 406 x 55 mm  
2 1/8" x 1'-4" x 2 1/8"

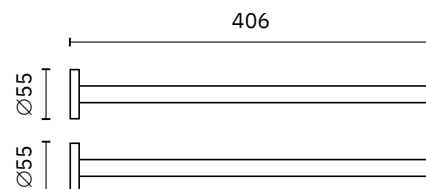

16220.60.N

24,85 €

Toallero

Dimensiones  
26 x 600 x 70 mm  
1" x 23 5/8" x 2 3/4"

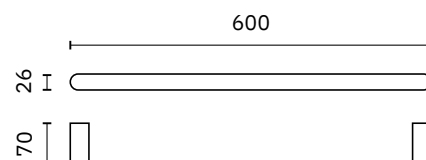

16220.40.N

21,40 €

Toallero

Dimensiones  
26 x 400 x 70 mm  
1" x 15 3/4" x 2 3/4"

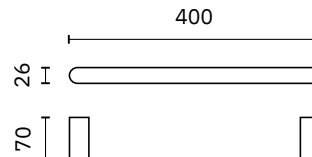

16226.N

41,50 €

Repisa de utilidad

Dimensiones  
26 x 500 x 126 mm  
1" x 19 3/4" x 5"

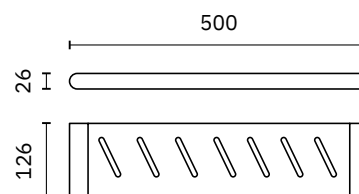

16223.N

90,00 €

Toallero con barra inferior

Dimensiones  
150 x 600 x 220 mm  
5 7/8" x 23 5/8" x 8 5/8"

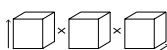
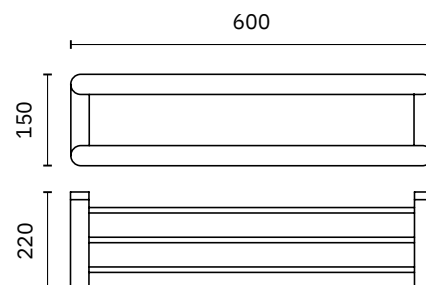

# capri negro

NUEVO

- ✓ Colección de accesorios de baño realizada en aluminio
  - ✓ Complementos de vidrio
  - ✓ Tornillería de acero inoxidable
  - ✓ Sistema de fijación roscada a pared mediante pletina
- Material  
Aluminio
- Acabado  
Negro (.N)

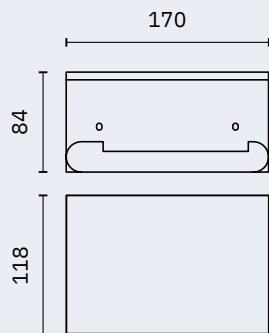

16228.N

22,80 €

Portarrollos de papel  
higiénico

Dimensiones  
84 x 170 x 118 mm  
3 1/4" x 6 3/4" x 4 5/8"

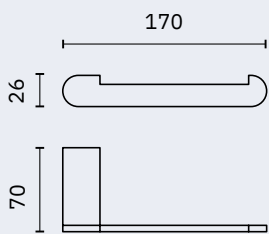
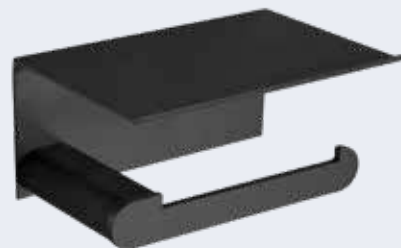

16229.N

15,85 €

Portarrollos de papel  
higiénico

Dimensiones  
26 x 170 x 70 mm  
1" x 6 3/4" x 2 3/4"

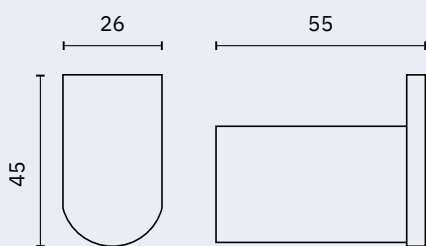

16221.N

9,60 €

Percha

Dimensiones  
45 x 26 x 55 mm  
1 3/4" x 1" x 2 1/8"

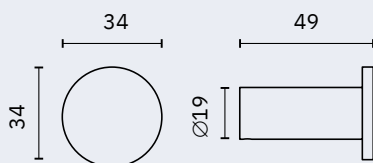

16873.N

13,20 €

Percha

Dimensiones  
34 x 34 x 49 mm  
1 3/8" x 1 3/8" x 1 7/8"

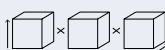
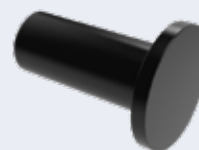

# capri negro

NUEVO

- ✓ Colección de accesorios de baño realizada en aluminio
- ✓ Complementos de vidrio
- ✓ Tornillería de acero inoxidable
- ✓ Sistema de fijación roscada a pared mediante pletina

Material  
Aluminio

Acabado  
Negro (.N)



16225.N

17,55 €

Jabonera de vidrio con soporte mural

Dimensiones  
40 x 135 x 88 mm  
1 5/8" x 5 1/4" x 3 1/2"

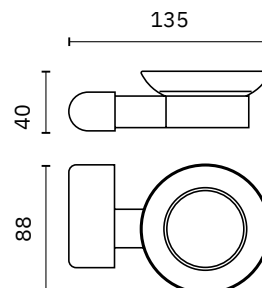

16231.N

15,70 €

Vaso para cepillo de dientes con soporte a pared

Dimensiones  
95 x 114 x 93 mm  
3 5/8" x 4 1/2" x 3 5/8"

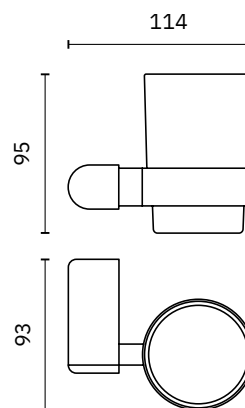

16227.N

31,00 €

Escobillero

Dimensiones  
350 x 144 x 94 mm  
1'-1 3/4" x 5 5/8" x 3 3/4"

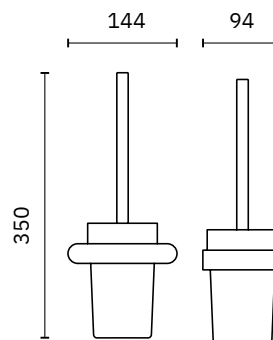

09078.N

31,40 €

Escobillero con soporte a pared

Material  
Acero inoxidable

Dimensiones  
382 mm x Ø 105 mm  
1'-3" x Ø 4 1/4"

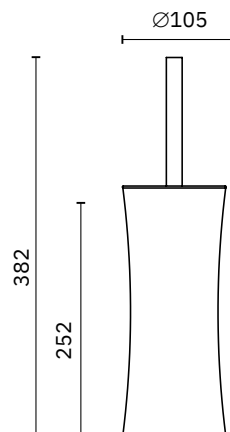



# black

Material  
ABS

Acabado  
Negro tacto suave

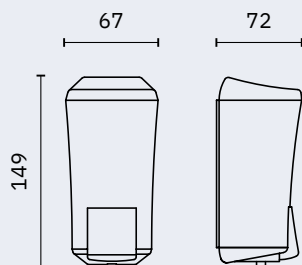

03010.N
<b>40,80 €</b>

Dosificador mural de jabón líquido rellenable

Dimensiones  
149 x 67 x 72 mm  
5 7/8" x 2 7/8" x 2 7/8"

Capacidad  
170 ml

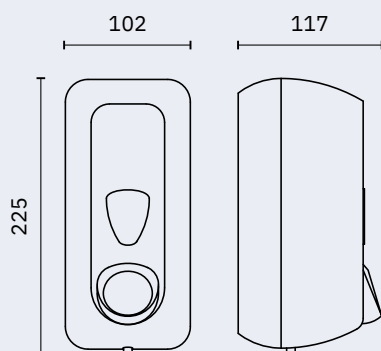

03011.N
<b>56,80 €</b>

Dosificador mural de jabón líquido rellenable

Dimensiones  
225 x 102 x 117 mm  
8 7/8" x 4" x 4 5/8"

Capacidad  
550 ml

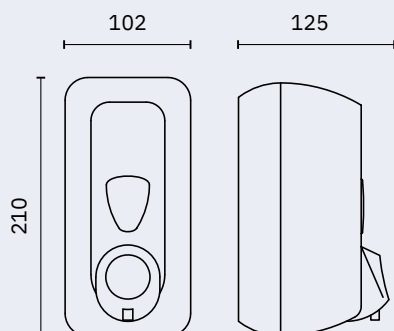

03012.N
<b>63,00 €</b>

Dosificador mural de jabón en espuma rellenable con cartucho

Dimensiones  
210 x 102 x 125 mm  
8 1/4" x 4" x 4 7/8"

Capacidad  
500 ml

Consumible  
Cartucho de recarga 06025.K  
(P.V.P.: 8,45 €)

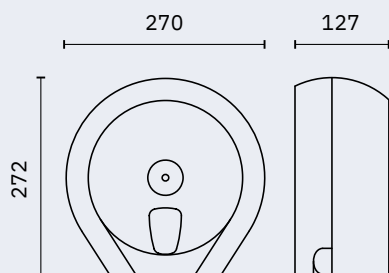

05010.N
<b>64,00 €</b>

Dispensador industrial de papel higiénico

Dimensiones  
272 x 270 x 127 mm  
10 3/4" x 10 5/8" x 5"

Rollo máximo: Ø 230 mm  
Eje Ø: 42 mm

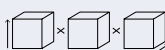

# black

Material  
ABS

Acabado  
Negro tacto suave



05011.N
<b>68,90 €</b>

Dispensador industrial gigante de papel higiénico

Dimensiones  
332 x 325 x 127 mm  
1'-1 1/8" x 1'-0 3/4" x 5"

Rollo máximo: Ø 290 mm  
Eje Ø: 42 mm

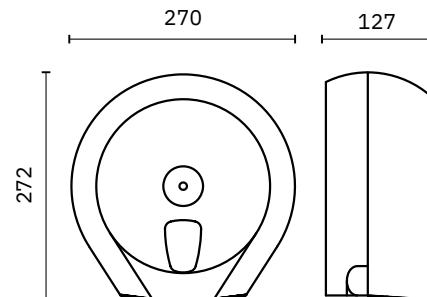

05012.N
<b>24,30 €</b>

Dispensador de papel higiénico

Dimensiones  
135 x 150 x 150 mm  
5 3/8" x 5 7/8" x 5 7/8"

Capacidad  
Rollo doméstico

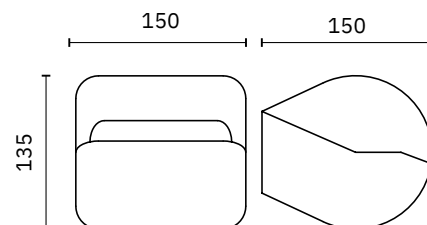

04030.N
<b>44,60 €</b>

Dispensador de papel higiénico en toallitas bulkpack

Dimensiones  
210 x 160 x 125 mm  
8 1/4" x 6 1/4" x 4 7/8"

Capacidad  
350 toallas

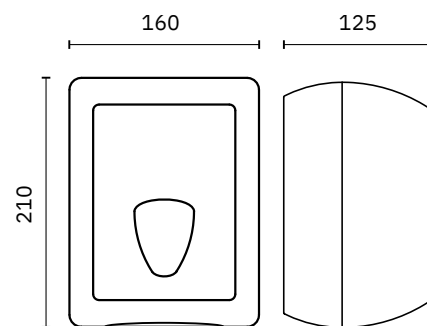

04031.N
<b>67,50 €</b>

Dispensador de papel toalla

Dimensiones  
300 x 290 x 110 mm  
11 3/4" x 11 3/8" x 4 3/8"

Capacidad  
250 toallas

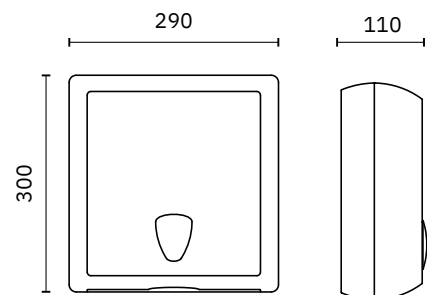

# black

Material  
ABS

Acabado  
Negro tacto suave

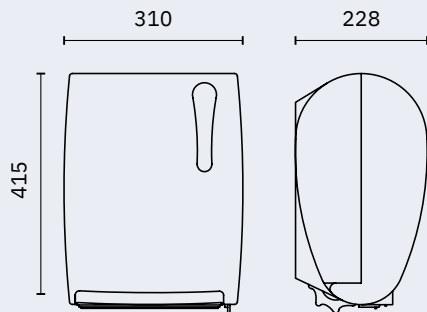

04032.N

219,50 €

Dispensador de papel toalla  
CORTE AUTOMÁTICO. Salida  
manual, corte automático.  
Funcionamiento con baterías

Dimensiones  
415 x 310 x 228 mm  
1'-4 3/8" x 1'-0 1/4" x 9"

Rollo máx. Ø 190 x 220 mm

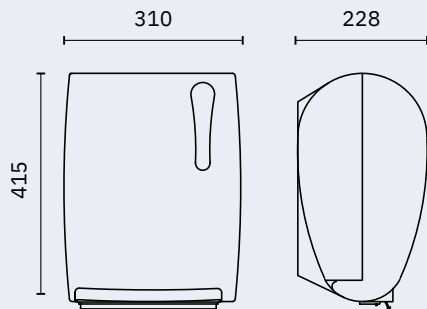

04033.N

273,00 €

Dispensador de papel toalla  
electrónico. Salida automática,  
CORTE MANUAL. Funcionamiento  
con baterías

Dimensiones  
415 x 310 x 228 mm  
1'-4 3/8" x 1'-0 1/4" x 9"

Rollo máx. Ø 200 x 220 mm

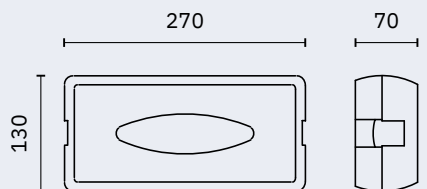

04027.N

31,90 €

Dispensador de pañuelos

Dimensiones  
70 x 270 x 130 mm  
2 3/4" x 10 5/8" x 5 1/8"

Capacidad  
Caja de pañuelos

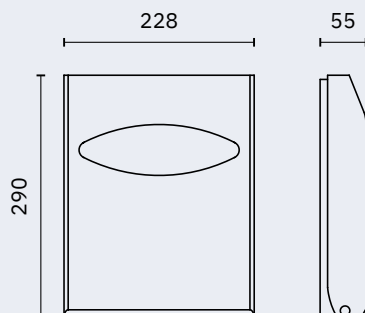

04028.N

48,60 €

Dispensador de aros higiénicos

Dimensiones  
290 x 228 x 55 mm  
11 3/8" x 9" x 2 1/8"

Capacidad  
200 aros plegados



# black

Material  
ABS

Acabado  
Negro tacto suave



04029.N

17,55 €

Dispensador de bolsitas  
higiénicas

Dimensiones  
95 x 135 x 32 mm  
3 3/4" x 5 3/8" x 1 1/4"

Capacidad  
25 bolsas

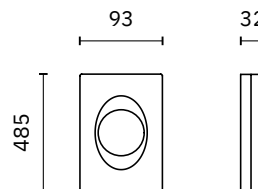

09108.N

69,70 €

Escobillero de pie base cromada

Dimensiones  
485 x 120 x 120 mm  
1'-7 1/8" x 4 3/4" x 4 3/4"

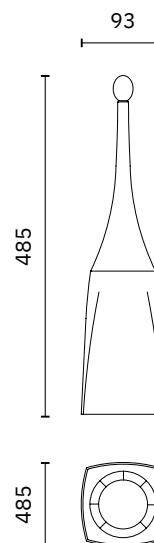

09109.N

44,80 €

Escobillero de pared soporte  
cromado

Dimensiones  
485 x 93 x 120 mm  
1'-7 1/8" x 3 5/8" x 4 3/4"

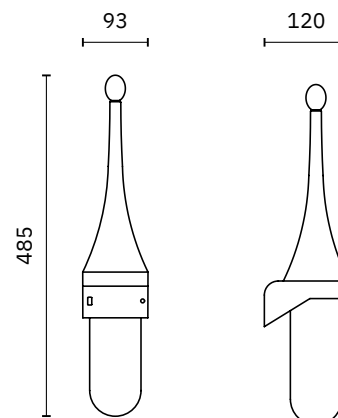

# black

Material  
ABS

Acabado  
Negro tacto suave

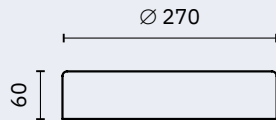

14029.N

15,35 €

Aro sujetabolsas para papeleras

Dimensiones  
60 mm. x  $\varnothing$  270 mm  
2 3/8" x  $\varnothing$  10 5/8"

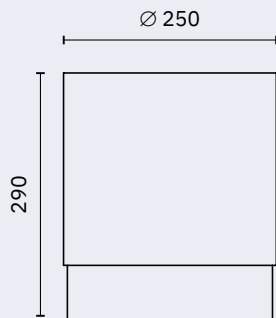

14028.N

41,80 €

Papelera de pie

Dimensiones  
290 mm.  $\varnothing$  250 mm  
11 3/8"  $\varnothing$  9 7/8"

Capacidad  
13 litros

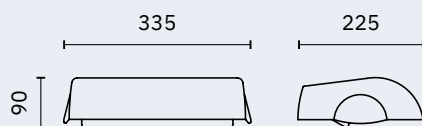

14040.N

14,05 €

Tapa para papeleras

Dimensiones  
90 x 335 x 225 mm  
3 1/2" x 1'-1 1/4" x 8 7/8"

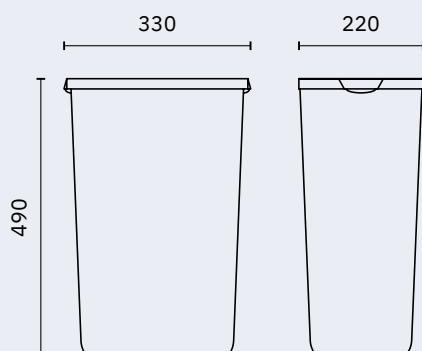

14030.N

37,30 €

Papelera de pie

Dimensiones  
490 x 330 x 220 mm  
1'-7 1/4" x 1'-1" x 8 5/8"

Capacidad  
23 litros

